

## **USER'S GUIDE TO THE INSTALLATION AND OPERATION OF THE**

### **Model ST-25AMC and ST-25AMT Mobilecall<sup>®</sup> Voice Encryption Modules**

ST-25AMC for use in Motorola MC-2100 Transceivers and  
ST-25AMT for use in Motorola MT-2100 Transceivers

Export of this product is under the jurisdiction of the U.S. Department of State, Office of Defense Trade Control. An Export License is Required

## **DISCLAIMER**

This is the installation procedure for Selectone equipment based on the best information available to us at the time of publication. Selectone assumes no responsibility for the accuracy of the information or the damage to equipment resulting from the use of this procedure.

## **WARRANTY POLICY**

All standard Selectone products are guaranteed to meet or exceed published performance specifications and are warranted against defects in material and workmanship for a period of five years from date of purchase. Special configurations and nonstandard systems are also warranted for a period of one year.

If any standard Selectone product fails to operate within the first 90 days from the date of purchase, Selectone will immediately send a replacement unit postpaid via airmail or UPS Blue Label (air), and will issue full credit, including freight, upon the return of defective unit(s). For special warranty replacement service, call the Selectone Customer Service Department TOLL FREE at 1-800-227-0376. C.O.D. customers must return defective equipment prior to exchange or will receive the replacement C.O.D. with credit issued only on return of the defective equipment.

After 90 days, this warranty is specifically limited to correction of the defects by factory repair or replacement of faulty equipment or parts.

All warranty repairs must be performed at the Selectone factory in Hayward, California. No credit will be given for unauthorized repair work attempted by the customer. Any unauthorized alteration or modification of the equipment, damage by external sources, or removal or alteration of the serial number label or date code, will void the warranty. Specifically excluded from this warranty is damage caused by lightning, power surges, or mechanical abuse.

Equipment for repair may be returned to the factory without prior written authorization; however, a note must be sent with the packing list briefly describing the nature of the defect.

For further information or technical assistance, please contact:

### **SELECTONE APPLICATIONS ENGINEERING DEPARTMENT**

23278 Bernhardt Street • Hayward, CA. 94545-1621 • (510) 887-1950  
Nationwide Toll Free: (800) 227-0376 • Fax: (510) 887-4011

## **TRADEMARKS**

Mobilecall is a registered trademark of Selectone Corporation

---

# Contents

---

**CONTENTS.....iii**

**INTRODUCTION ..... v**  
    SPECIFICATIONS ..... v

**1 • OPERATION..... 1-1**

**MC-2100 OPERATION (with an ST-25AMC installed) .....1-1**  
        Normal Non-secure Voice Operation ..... 1-1  
        Encrypted Voice Reception ..... 1-1  
        Encrypted Voice Transmissions ..... 1-1  
        User Code Key Switching ..... 1-2

**MT-2100 OPERATION (with an ST-25AMT installed).....1-2**  
        Normal Non- Encrypted Voice Operation ..... 1-2  
        Encrypted Voice Reception ..... 1-2  
        Encrypted Voice Transmissions ..... 1-2  
        User Code Key Switching ..... 1-2

**INITIAL SYNCHRONIZATION DELAY .....1-3**

**2 • PROGRAMMING ..... 2-1**

**VOICE ENCRYPTION MODULE PROGRAMMING.....2-1**  
        ST-907 Programmer ..... 2-1  
        ST-905 Programmer ..... 2-1  
        Initial Synchronization Delay (Parameter 0) ..... 2-2  
        User Code Keys (Parameters 3, 1, 2, \*) ..... 2-2  
        Operating Mode (Parameter 9) ..... 2-3

**ADJUSTMENTS.....2-3**

**3 • INSTALLATION..... 3-1**

**ST-25AMC (For use with Motorola MC-2100 Transceivers) .....3-1**

**ST-25AMT (For use with Motorola MT-2100 Transceivers) .....3-3**

**APPENDIX A • REFERENCE DRAWINGS**

Figure 1 - ST-25AMC Cable Drawing..... A-1  
Figure 2 - Motorola MC-2100 Main Board (Side 1) ..... A-2  
Figure 3 - Motorola MC-2100 Main Board (Side 2) ..... A-3  
Figure 4 - Motorola MC-2100 Control Head ..... A-4  
Figure 5 - ST-25AMT Cable Drawing..... A-5  
Figure 6 - Motorola MT-2100 Controller Board (Side 1)..... A-6  
Figure 7 - Motorola MT-2100 Controller Board (Side 2)..... A-7  
Figure 8 - ST-25AMC/AMT Schematic Diagram..... A-8  
Figure 9 - ST-25AMC/AMT Component Locator..... A-9

**LIST OF TABLES**

Table 1 - Programming Summary ..... 2-3

---

# Introduction

---

The ST-25AMC and ST-25AMT are voice encryption devices for use with the Motorola MC-2100 & MT-2100 Transceivers respectively. The cipher process uses a proprietary microprocessor controlled digital scrambling algorithm. Each unit can be programmed with up to four User Code Keys, with over 4 billion code keys to choose from for each User Code Key. Special factory set master code key groups are reserved to provide extra security for special services. Each master code key group has over 268 million possible code keys. To maintain security, code keys are never transmitted. Audio processing filters provide high quality low distortion recovered audio. **NOTE:** *Though the ST-25AMT can accept four user code keys, the application characteristics of the MT-2100 radio limits the accessibility to only one User Code Key.*

## SPECIFICATIONS

Total Code keys:	Over 4 billion
Operating Voltage:	5.2 to 18Vdc
Operating Current:	< 8mA
User Code keys:	Over 268 million
Ciphered Algorithm:	Real time frequency domain
Synchronization:	Initial and maintenance bursts
Delay Before Initial Synchronization:	Programmable 50mS to 1.2S
Input to Output Gain:	Less Than $\pm 0.5$ dB
Frequency Response:	300 Hz to 2600 Hz.
Programming:	External Keypad (ST-905 V1.3 or greater) PC Programmer (ST-907 VER 3.2 or greater)
Memory:	Non-volatile EEPROM
Indicators:	Audible (Spkr. Beep)
Digital Inputs:	Logic Low, less than 1 Vdc Logic High, Greater than 4 Vdc
Temp. Range:	30°C to +70°C
Interface:	Flying leads terminated at a low profile connector
Size:	Customized to permit installation in the MT-2100 transceiver.

Specifications are subject to change without notice.

This page intentionally left blank.

---

# 1 • Operation

---

**CAUTION**

Operation of radio equipment with encrypted speech capability may be government regulated. You are responsible for compliance with applicable radio regulations regarding operation of this equipment.

The ST-25AMC and ST-25AMT circuit boards are identical. The only differences are the application details and programming to accommodate the specific application. Operation is almost transparent to the user. The user has the capability to enable or disable the transmit cipher mode. Once enabled all subsequent transmissions will be ciphered using the selected code key (User Code Key selection is not available with the ST-25AMT). Ciphered reception is automatic; other units transmitting with the selected code key will be automatically deciphered. Clear transmissions will also be received automatically.

## MC-2100 OPERATION (with an ST-25AMC installed)

---

### Normal Non-Encrypted Voice Operation

Upon power-up MC-2100 operation is not noticeably different than operation prior to installation of the ST-25AMC. All normal MC-2100 functions and operational capabilities are unchanged. If the radio receives a clear, non-ciphered signal the clear audio will be heard on the speaker. If the radio operator presses the PTT button and speaks into the microphone transmissions will be “in the clear” (non-ciphered).

### Encrypted Voice Reception

If a synchronization signal from another correctly coded Selectone ST-25 series Encrypted Voice device is received, the ST-25AMC will automatically switch to de-cipher mode. De-ciphered audio will be heard on the speaker. If a synchronization signal from an incorrectly coded Selectone ST-25 series Encrypted Voice device is received, unintelligible ciphered audio will be heard on the speaker.

### Encrypted Voice Transmissions

To produce ciphered transmissions the ST-25AMC must be placed in the ciphered transmission mode. This is accomplished by special operation of the monitor switch on the radio. This switch is the lower left most switch on the radio front panel. The monitor switch provides a dual function. First it operates normally for radio functions. Secondly the user can toggle between Clear/Ciphered transmissions by operating the switch two times in rapid succession (Double Clicking). The ST-25AMC will then provide a tone output to the radio speaker. A high frequency beep indicates subsequent transmissions will be Ciphered. A low frequency tone for .5 Sec. indicates subsequent transmissions will be “in the clear” non-ciphered. Normally following power-up, operation will be in the clear mode. The user must take the above described action to select the ciphered transmission mode.

*The power-up condition may be altered if required during programming (power-up in ciphered transmission mode, switch to clear transmissions).*

## **User Code Key Switching**

The double click mode described above also provides access to User Code Key selection. To select an Alternate Code Key, operate the monitor switch four times in rapid succession (Quad Clicking). Each Quad Click sequence advances the selected User Code Key one step around a loop of four possible selections (Primary, First Alternate, Second Alternate, Third Alternate, Primary...). Following a Quad Click sequence the ST-25AMC responds with speaker beeps to indicate the selection position.

Primary	1 beep
First Alternate	2 beeps
Second Alternate	3 beeps
Third Alternate	4 beeps

When returning to ciphered transmission mode from clear transmission mode, the last used User Code Key will be retained and indicated with speaker beeps. User Code Key selection is initialized at the Primary User Code Key on power-up.

## **MT-2100 OPERATION (with an ST-25AMT installed)**

---

### **Normal Non-Encrypted Voice Operation**

Upon power-up MT-2100 operation is not noticeably different than operation prior to installation of the ST-25AMT. All normal MT-2100 functions and operational capabilities are unchanged. If the radio receives a clear, non-ciphered signal the clear audio will be heard on the speaker. If the radio operator presses the PTT button and speaks into the microphone transmissions will be “in the clear” (non-ciphered).

### **Encrypted Voice Reception**

If a synchronization signal from another correctly coded Selectone ST-25 series Encrypted Voice device is received, the ST-25AMT will automatically switch to de-cipher mode. De-ciphered audio will be heard on the speaker. If a synchronization signal from an incorrectly coded Selectone ST-25 series Encrypted Voice device is received, unintelligible ciphered audio will be heard on the speaker.

### **Encrypted Voice Transmissions**

To produce ciphered transmissions the ST-25AMT must be placed in the ciphered transmission mode. This is accomplished by operating the toggle switch on the top of the radio. All transmissions made with the switch in position A produces Ciphered transmissions. The other two positions produce “in the clear” (non-ciphered) transmissions.

### **User Code Key Switching**

Due to the lack of availability of switches on this radio this function is NOT available.

## **INITIAL SYNCHRONIZATION DELAY**

---

All radio systems have an operating delay. This is the time between PTT activation at a transmitter and speaker audio being available at the receiving point. This time may vary considerably from system to system or even from transmission to transmission. For reliable cipher operation the ST-25AMC or ST-25AMT must wait for this time period before signaling the beginning of a ciphered transmission. System delays must be evaluated and accommodated with the INITIAL SYNCHRONIZATION DELAY parameter. This parameter is described in the programming section of this manual.

For many radio operators it is difficult to reliably know how long to wait before speaking in ciphered mode. This can cause loss of the beginning of a message. The ST-25AMC can be programmed to compensate for this problem. For cipher transmissions the ST-25AMC will provide all the necessary timing and beep the speaker as a "GO AHEAD" and speak indication. Due to the design of the MT-2100 it is not practical to use the speaker beep capabilities of the ST-25AMT.

This page intentionally left blank.

---

## 2 • Programming

---

### VOICE ENCRYPTION MODULE PROGRAMMING

---

Field programming is accomplished with either the ST-905 Keypad Programmer or the ST-907 PC based programmer. The ST-905 Keypad Programmer must be Version 1.3 or greater. The version can be found on the bottom of the unit printed on a small white tag. Version 1.3 will read "V1.3". The ST-907 version must be Version 3.2 or greater. Version 3.2 will be displayed as VER 3.2 in the upper right hand corner of the display screen when running the ST-CONFIG program. **Older versions of either the ST-905 or ST-907 will not properly program the ST-25AMC or ST-25AMT.**

Whether using the ST-907 or the ST-905 there are 6 parameters to be considered for programming. They are:

- |   |             |
|---|-------------|
| • Initial Synchronization Delay                               | Parameter 0 |
| • Primary User Code Key                                       | Parameter 3 |
| • First Alternate User Code Key (Not usable in the ST-25AMT)  | Parameter 1 |
| • Second Alternate User Code Key (Not usable in the ST-25AMT) | Parameter 2 |
| • Third Alternate User Code Key (Not usable in the ST-25AMT)  | Parameter * |
| • Operating Mode (Switched/Double Click)                      | Parameter 9 |

#### **ST-907 Programmer**

The ST-907 uses the DOS program ST-CONFIG and provides all necessary hookup and programming information as screen prompts. The program will ask for a password before displaying the programmed setting of an ST-25AMC or ST-25AMT. The factory default password is "00000000". You should change the password when programming the units. The ST-907 connects to the ST-25AMC or ST-25AMT with the SPECIAL order cable (P/N 502-2920).

#### **ST-905 Programmer**

To use the ST-905 use the following procedure.

1. Connect the Red (+) and Black (-) leads of the ST-905 to a 6 to 18 Vdc power source (a 9 Vdc transistor radio battery is an acceptable power source).
2. Connect the ST-905 to the ST-25AMC or ST-25AMT with the SPECIAL order cable (P/N 502-2920).
3. Enter the value desired.
4. Press \* and # simultaneously [\*#].
5. Enter the parameter number.
6. Repeat steps 3 through 5 for each parameter.

## Initial Synchronization Delay (Parameter 0)

---

Nine possible entries are available for this parameter. The value selected determines the delay time the ST-25AMC or ST-25AMT will use between operation of the PTT and Initial Synchronization. Delays are available in 100mS steps from 50mS to 850mS. The value entered is the 100's digit of the required delay.

If 9 is entered the delay is set to 1.2 Sec. At the end of this time period an audible beep is sent to the speaker. The beep indicates "GO AHEAD" and speak. For many systems the 9 selection will provide the most friendly user interface. However the beep outputs must be connected for this feature to be effective. **Note:** Due to the design of the MT-2100 it is not practical to use the speaker beep capabilities of the ST-25AMT. Without speaker beep, delay selection 9 provides no special value.

**Example:** 0 = 50mS, 1 = 150mS, 2 = 250mS etc.  
9 = 1.2Sec .

## User Code Keys (Parameters 3, 1, 2, \*)

---

**NOTE**



The security of your system depends on the secrecy of your code keys. For secure operation we recommend changing your code keys often. The ST-905 or ST-907 CANNOT be used by another party to compromise your code key selections.

*The Primary User Code Key is the only code key available to the ST-25AMT. It is not necessary to program the Alternate User Code Keys in the ST-25AMC if they are not to be used.*

User Code Keys may be any combination of keypad characters in a seven digit sequence. This seven digit sequence allows for more than 268 million code keys. The default values for the four User Code Keys are as follows.

User Code Key	Parameter	Default Code Key
Primary	3	4444444
First Alternate	1	2222222
Second Alternate	2	3333333
Third Alternate	*	1111111

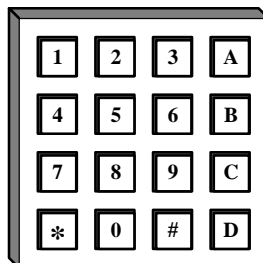

Available Code Key Characters

## Operating Mode (Parameter 9)

This parameter has two possible values.

- ◆ Double Click Mode      Required setting for correct operation of ST-25AMC
- ◆ Switched mode            Required setting for correct operation of ST-25AMT

**Table 1 - Programming Summary**

FEATURE	ST-905 PROGRAMMING SEQUENCE	FACTORY DEFAULT
Initial Synchronization (Parameter 0)	[value] [*#] 0  <b>Values:</b> 0 = 50mS,                      5 = 550mS, 1 = 150mS,                    6 = 650mS, 2 = 250mS,                    7 = 750mS, 3 = 350mS,                    8 = 850mS, 4 = 450mS,                    9 = 1.2S with beep	2 (250mS)
Primary User Code Key (Parameter 3)	[7 digit code key] [*#] 3	4444444
First Alternate User Code Key (Parameter 1)	[7 digit code key] [*#] 1	2222222
Second Alternate User Code Key (Parameter 2)	[7 digit code key] [*#] 2	3333333
Third Alternate User Code Key (Parameter *)	[7 digit code key] [*#] *	1111111
Operating Mode (Parameter 9)	1 [*#] 9 = (Double Click), power up CLEAR (ST-25AMC) 2 [*#] 9 = (Switched), power up CLEAR (ST-25AMT) 3 [*#] 9 = (Double Click), power up CIPHER (ST-25AMC)	Switched

*The programming instructions for the ST-907 are displayed on screen when the ST-CONFIG program is run. Please note that the above chart does not depict the ST-CONFIG screen.*

## **ADJUSTMENTS**

---

There are no adjustments required for ST-25AMC or ST-25AMT operation.

## 3 • Installation

### ST-25AMC (For use with Motorola MC-2100 Transceivers)

**NOTE**

This application was developed using Motorola Publication No. 68P02058U21-O Issued 06.93

1. Prior to operation the following parameters will have to be programmed (described on pages 2-1, 2-2, 2-3)
  - ◆ Initial Synchronization Delay - (Parameter 0)  
The recommended value for the ST-25AMC is 9.
  - ◆ Operating mode - double click (Parameter 9)  
The ST-25AMC **MUST** be programmed to 1 or 3.
  - ◆ Primary User Code Key (Parameter 3) (must be reprogrammed, *do not use factory default*)
  - ◆ First Alternate User Code Key (Parameter 1) (available, but not required)
  - ◆ Second Alternate User Code Key (Parameter 2) (available, but not required)
  - ◆ Third Alternate User Code Key (Parameter \*) (available, but not required)
2. Disassemble the MC-2100 transceiver following the procedure detailed in the Motorola manual under the title “**DISASSEMBLY AND REASSEMBLY**”. It is not necessary to disassemble the Control Head. The Control Head is sufficiently serviceable without complete disassembly.
3. Prior to installation of the ST-25AMC, remove C0202 and R0224 on the MC-2100 Main Board. See Figure 2 on page A-2 for locations.
4. The ST-25AMC is mounted with the supplied double sided tape on the Side 1 of the Main Board as shown in Figure 2 on page A-2. See the following figure for placement of the supplied tape.

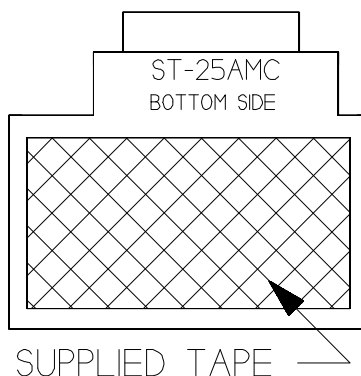

5. Wire lead lengths are critical for this application. Sample installations of this application at the Selectone factory have shown a qualified technician can produce the most professional results by personally cutting the wires to length. Figure 1 on page A-1 details the recommended wire lengths. If an error is made two spare White wires have been provided. To remove wires from the connector carefully lift the tab above the wire pin with a sharp tool, then pull the wire and pin from the connector body. Reinsert by pushing the pin into the connector body.
6. Most of the connection points are to existing SMD parts and will require careful soldering. Lead dress is also critical due to the limited space. Refer to Figures 2, 3, and 4 on pages A-2, A-3, and A-4 for connection and lead dress details.
7. The Orange, Yellow, and Violet wires have to be routed to Side 2 of the Main Board. The lead dress of these wires is extremely critical. If the wires are not dressed as shown in Figure 3, on page A-3 they may interfere with the re-installation of the metal cover/shield. In addition to interfering with the shield, the shield may pinch or even cut and short out incorrectly dressed wires.
8. The brown wire is supplied with a miniature inline connector in series. This connector Provides a convenient connection method between the radio chassis and the Control Head.
9. Reassemble the MC-2100 transceiver following the procedure detailed in the Motorola manual under the title “**REASSEMBLY**”. During reassembly the Brown wire is dressed through the rectangular notch in the metal chassis and the round hole in the plastic cover.
10. Before reconnecting the Control Head to the Transceiver section connect the two Brown wires together using the supplied inline connector.
11. Following complete reassembly the MC-2100 should function as previously described.

## ST-25AMT (For use with Motorola MT-2100 Transceivers)

**NOTE**

This application was developed using Motorola Publication No. 68P02058U30-O Issued 06.93

1. Prior to installation examine the MT-2100 controller board. If J701 is present it will have to be removed, or the ST-25AMT will not fit when the radio is reassembled.
2. Prior to operation the following parameters will have to be programmed (described on pages 2-1, 2-2, 2-3)
  - ◆ Initial Synchronization Delay (Parameter 0)  
Program for system requirements.
  - ◆ Primary User Code Key (Parameter 3) (must be reprogrammed, *do not use factory default*)
  - ◆ Operating mode (Parameter 9) - Clear/Ciphered  
The ST-25AMT **MUST** be programmed to 2.
3. Disassemble the MT-2100 transceiver following the procedure detailed in the Motorola manual under the title **“DISASSEMBLY AND REASSEMBLY”**.
4. Prior to installation of the ST-25AMT, remove C709 and R707 on the MT-2100 Controller Board. See Figure 7 on page A-7 for locations.
5. The metal crystal housing and the passive top side of the ST-25AMT are covered with a plastic insulator tape. The ST-25AMT is placed on top of the Controller Board as shown in Figure 6 on page A-6 . The board is held in place by the snug fit provided when the metal shield is in place.
6. Wire lead lengths are critical for this application. Sample installations of this application at the Selectone factory have shown a qualified technician can produce the most professional results by personally cutting the wires to length. Figure 5 on page A-5 details the wire lengths. If an error is made two spare White wires have been provided. To remove wires from the connector carefully lift the tab above the wire pin with a sharp tool, then pull the wire and pin from the connector body. Reinsert by pushing the pin into the connector body.
7. Most of the connection points are to existing SMD parts and will require careful soldering. Lead dress is also critical due to the limited space. Refer to Figures 6 and 7 on pages A-6 and A-7 for connection and lead dress details.
8. The Blue and Gray wires have to be routed to Side 2 of the Controller Board. The lead dress of these wires is extremely critical. If the wires are not dressed as shown in Figure 6 they may become pinched between the Controller Board and the chassis.
9. Reassemble the MT-2100 transceiver following the procedure detailed in the Motorola manual under the title **“REASSEMBLY”**.
10. Following complete reassembly the MT-2100 should function as previously described.

This page is intentionally left blank.



















This page intentionally left blank.

NOTE: WIRES ARE SHOWN AT ACTUAL LENGTH.

CONNECTOR

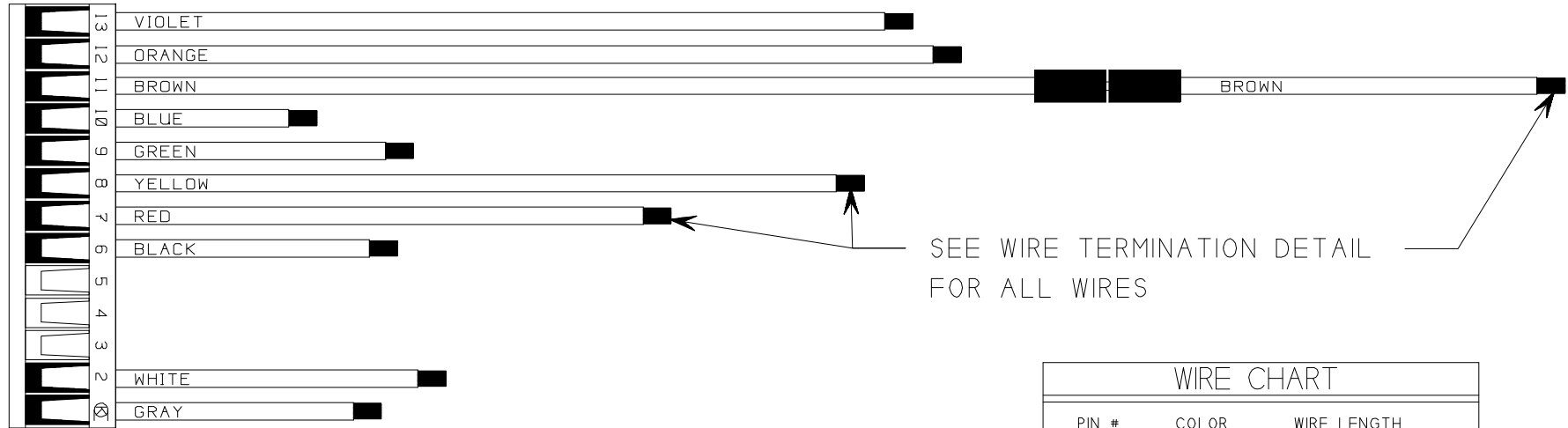

TOP VIEW

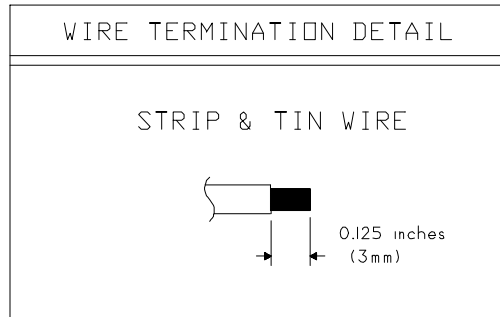

WIRE CHART		
PIN #	COLOR	WIRE LENGTH
1	GRAY	1.65 inches (42mm)
2	WHITE	2.05 inches (52mm)
6	BLACK	1.75 inches (44mm)
7	RED	3.45 inches (88mm)
8	YELLOW	4.65 inches (118mm)
9	GREEN	1.85 inches (47mm)
10	BLUE	1.25 inches (32mm)
11	BROWN	6.00 inches (164mm)
	BROWN	3.00 inches (39mm)
12	ORANGE	5.25 inches (133mm)
13	VIOLET	4.95 inches (126mm)

Figure 1 - ST-25AMC Cable Drawing

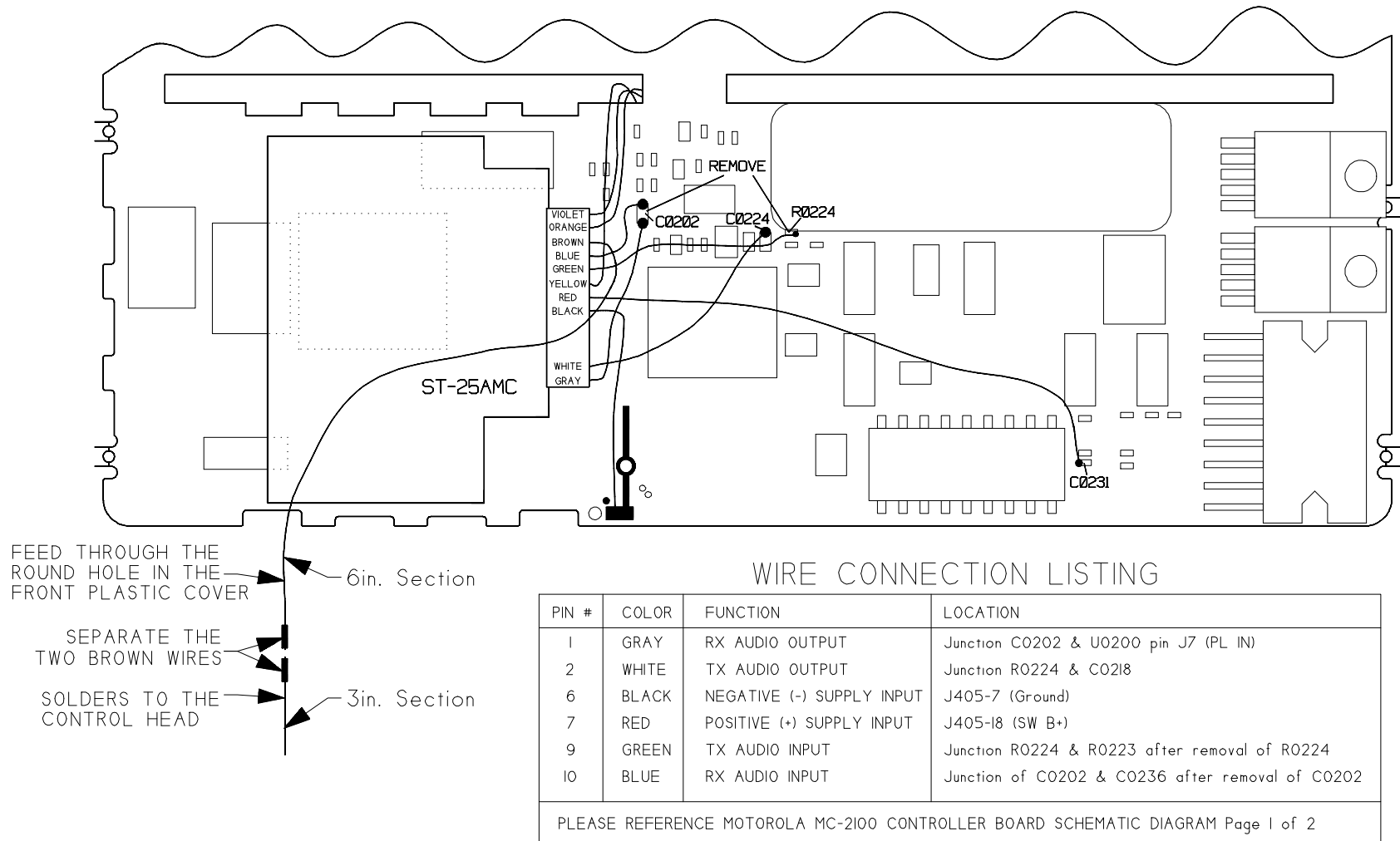

**Figure 2 - Motorola MC-2100 Main Board (Side 1)**

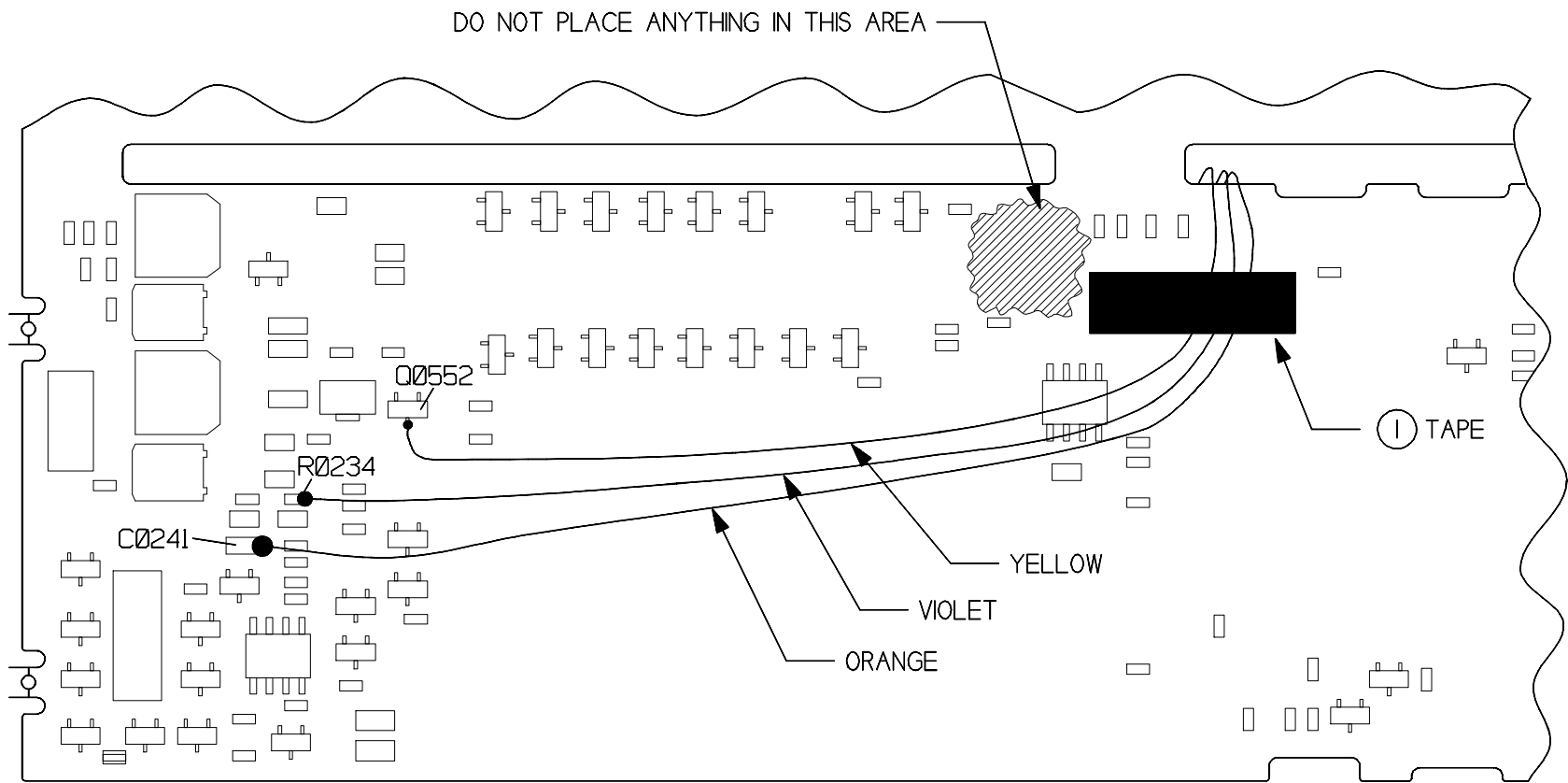

WIRE CONNECTION LISTING

PIN #	COLOR	FUNCTION	LOCATION
8	YELLOW	PTT INPUT	Q0552 Collector
12	ORANGE	PA ENABLE	Q0200 Base
13	VIOLET	BEEP	Junction R0234 & C0228

PLEASE REFERENCE MOTOROLA MC-2100 CONTROLLER BOARD SCHEMATIC DIAGRAM Page 2 of 2

NOTES:

① HOLD THESE WIRES IN PLACE WITH A SMALL PIECE OF TAPE.

**Figure 3 - Motorola MC-2100 Main Board (Side 2)**

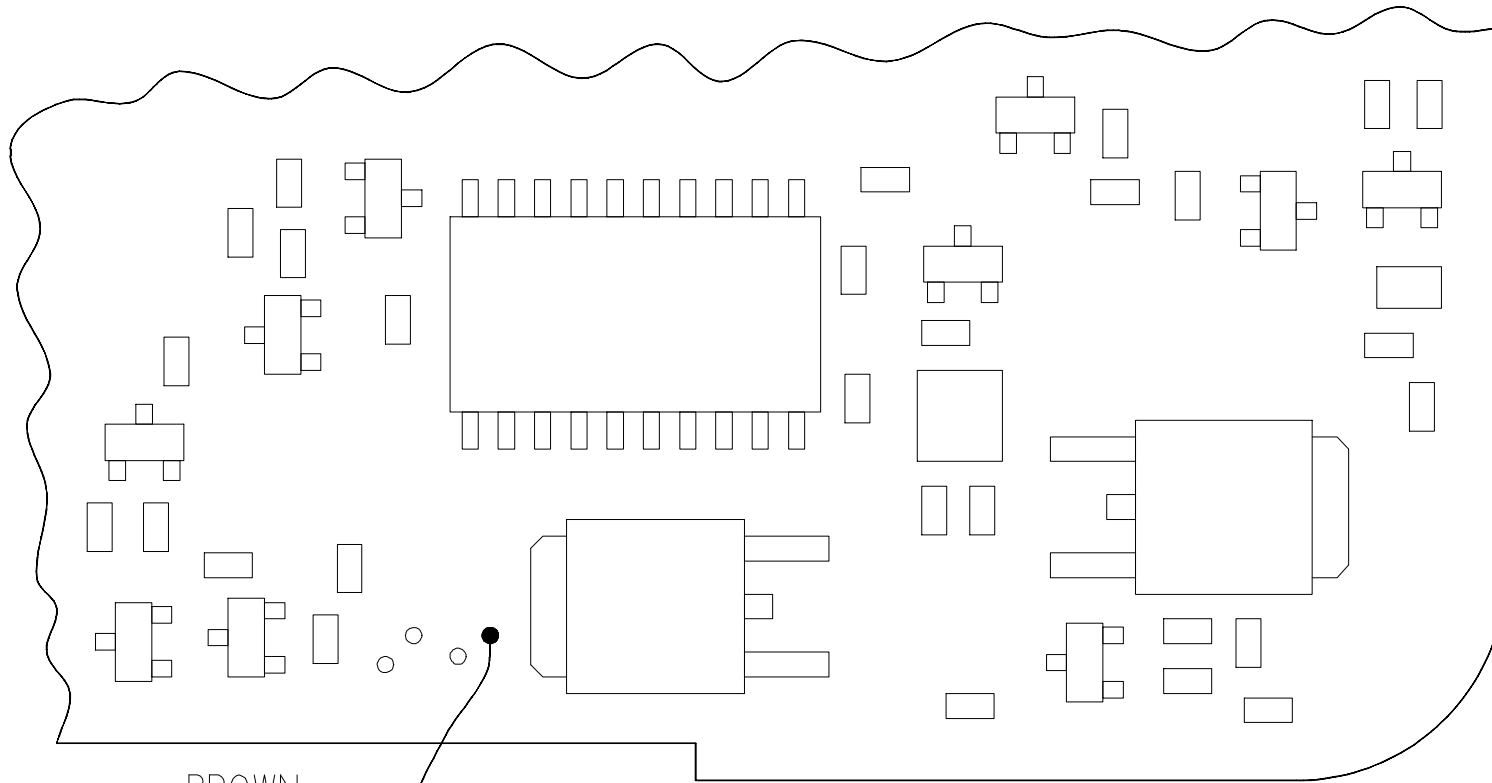

BROWN  
(3in. Section)

CONNECTS TO BROWN  
WIRE (6in. Section) FROM  
THE MAIN BOARD Side I

#### WIRE CONNECTION LISTING

PIN #	COLOR	FUNCTION	LOCATION
11	BROWN	CLEAR/CIPHER	Junction S0660 & R0673
PLEASE REFERENCE MOTOROLA MC-2100 CONTROL HEAD SCHEMATIC DIAGRAM			

**Figure 4 - Motorola MC-2100 Control Head**

WIRE CHART		
PIN #	30 GA WIRE COLOR	WIRE LENGTH
1	GRAY	3.1 inches (79mm)
2	WHITE	1.4 inches (36mm)
6	BLACK	0.8 inches (21mm)
7	RED	0.9 inches (23mm)
8	YELLOW	1.2 inches (31mm)
9	GREEN	1.8 inches (46mm)
10	BLUE	2.3 inches (59mm)
11	BROWN	1.5 inches (38mm)

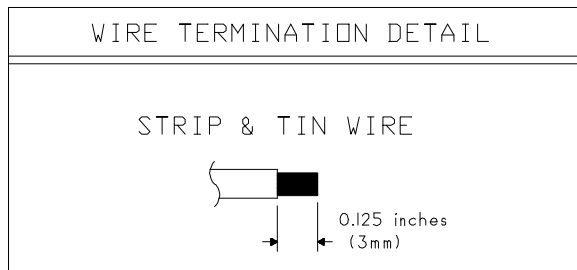

NOTE: WIRE LENGTHS ARE SHOWN AT ACTUAL LENGTH.

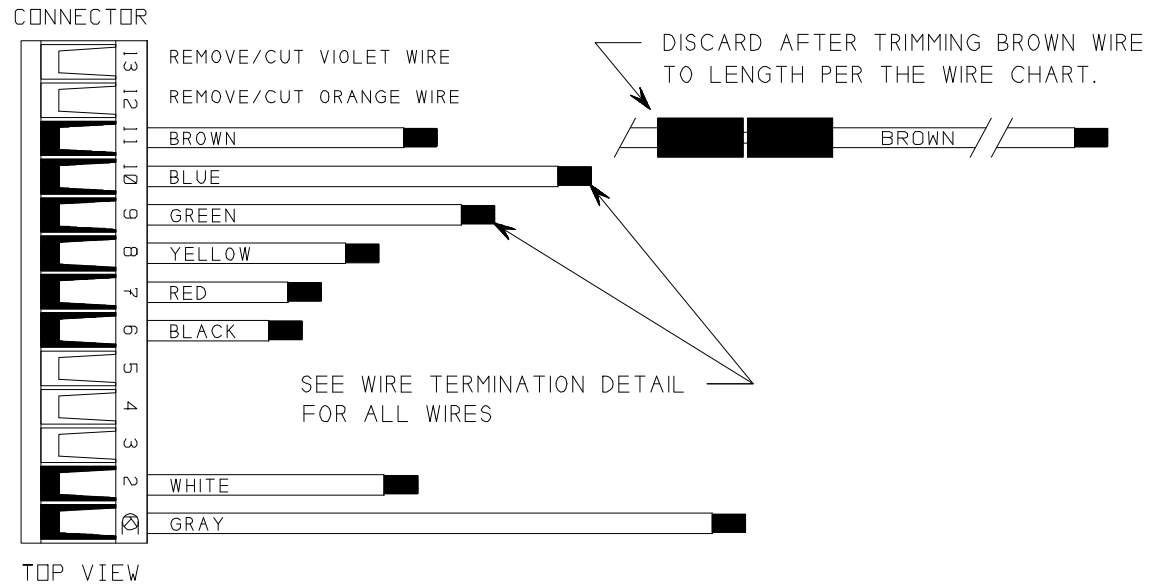

**Figure 5 - ST-25AMT Cable Drawing**

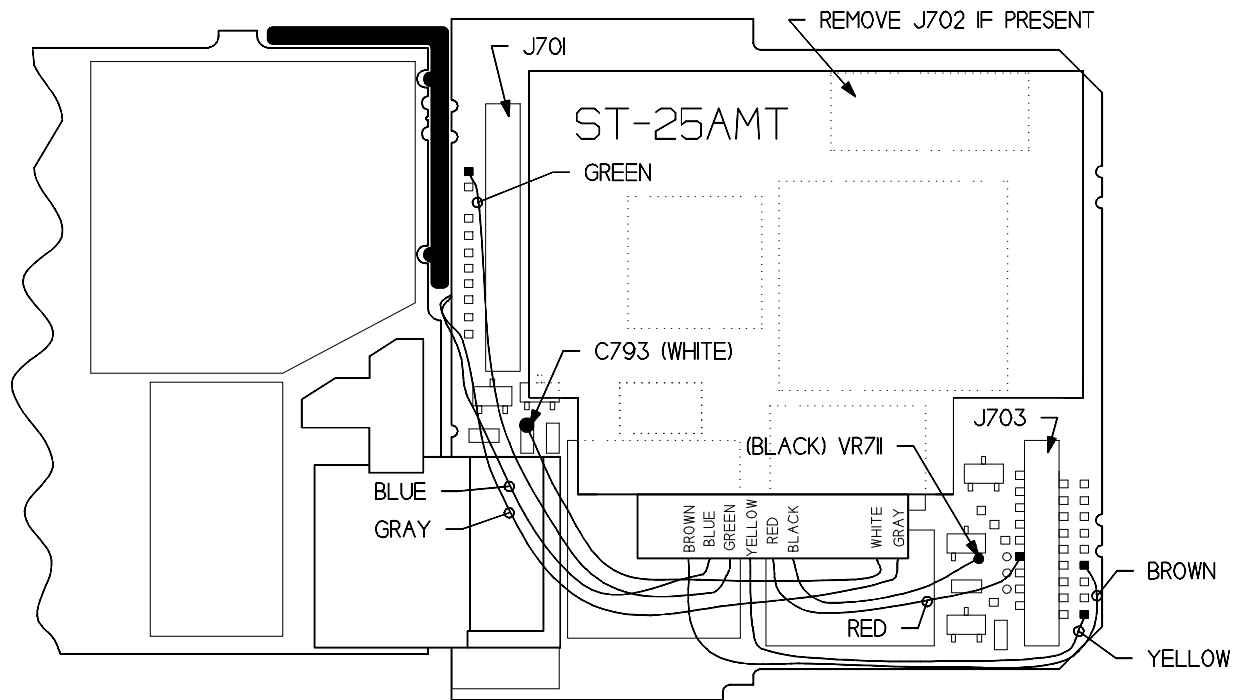

### WIRE CONNECTION LISTING

PIN #	COLOR	FUNCTION	LOCATION
2	WHITE	TX AUDIO OUTPUT	Junction R707 & C793
6	BLACK	NEGATIVE (-) SUPPLY INPUT	J703-4 (GND I)
7	RED	POSITIVE (+) SUPPLY INPUT	J703-8 (USER B+)
8	YELLOW	PTT INPUT	J703-1 (INT PTT)
9	GREEN	TX AUDIO INPUT	J701-7 (Junction R706 & R707) (INT MIC)
11	BROWN	CLEAR/CIPHER	J703-7 (SW5P0S) (Actually connects to S402-B)

PLEASE REFERENCE MOTOROLA MT-2100 NTN 7678A CONTROLLER BOARD SCHEMATIC DIAGRAM

**Figure 6 - Motorola MT-2100 Controller Board (Side 1)**

BE CAREFUL OF LEAD DRESS.  
 WIRES SHOULD NOT BE ROUTED IN THIS AREA.  
 IF WIRES GET BETWEEN THE PCB AND  
 THE CHASSIS, THEY MAY SHORT OUT.

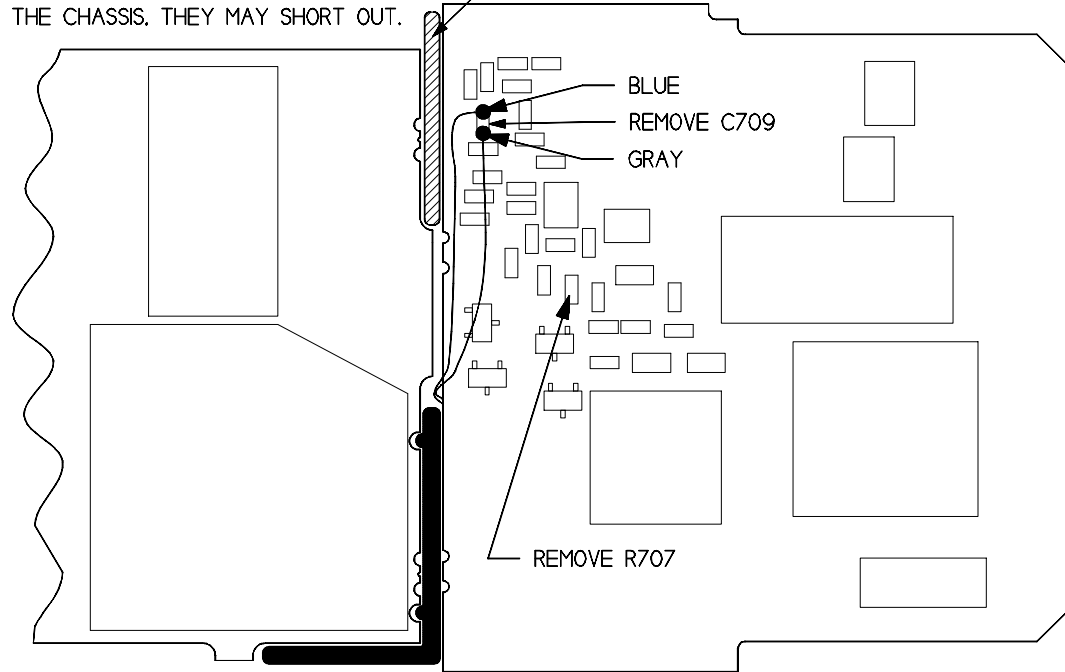

### WIRE CONNECTION LISTING

PIN #	COLOR	FUNCTION	LOCATION
1	GRAY	RX AUDIO OUTPUT	Junction C709 & U701 pin J7 (PL IN)
10	BLUE	RX AUDIO INPUT	Junction C709 & R761
PLEASE REFERENCE MOTOROLA MT-2100 NTN 7678A CONTROLLER BOARD SCHEMATIC DIAGRAM			

**Figure 7 - Motorola MT-2100 Controller Board (Side 2)**

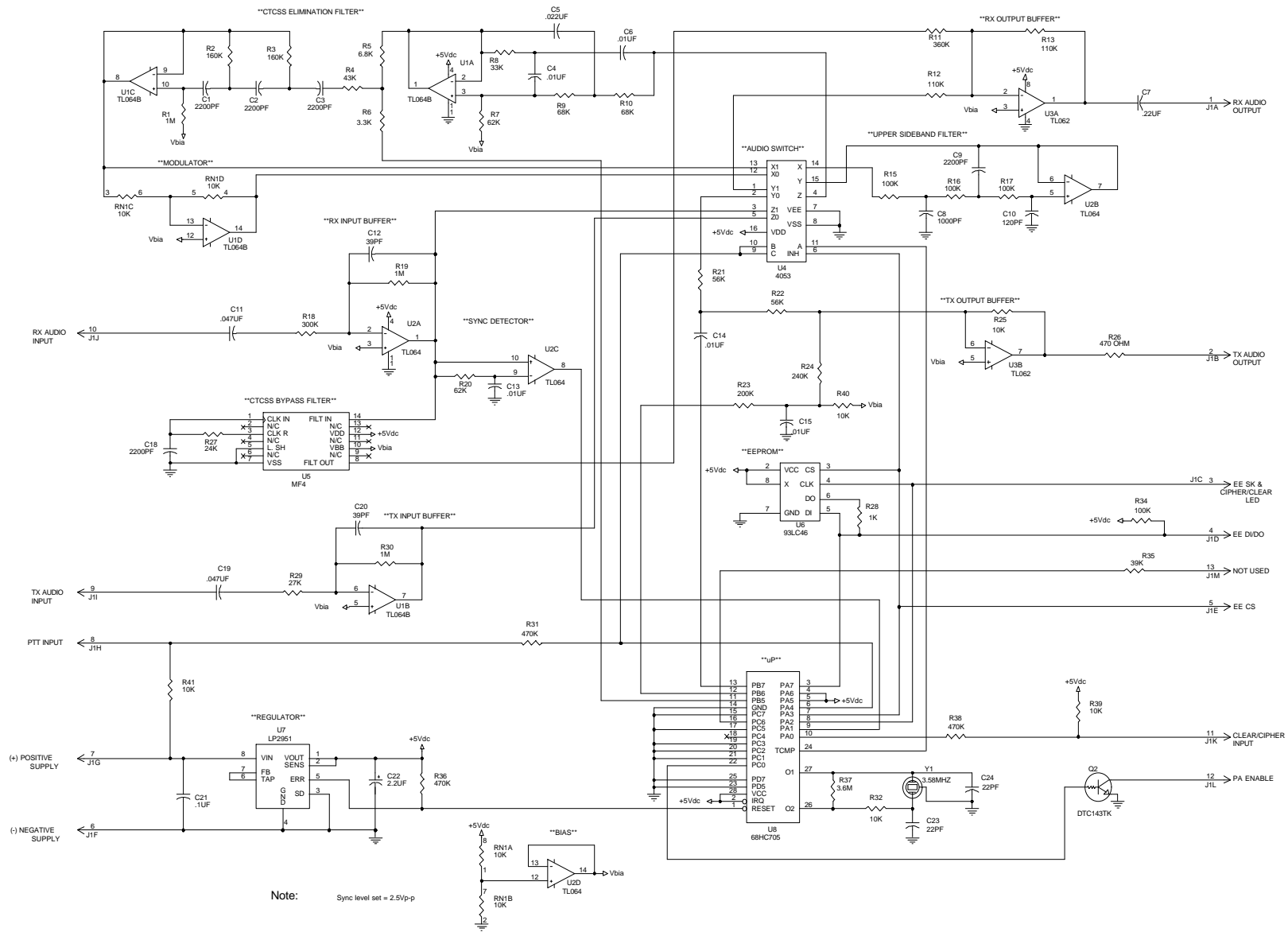
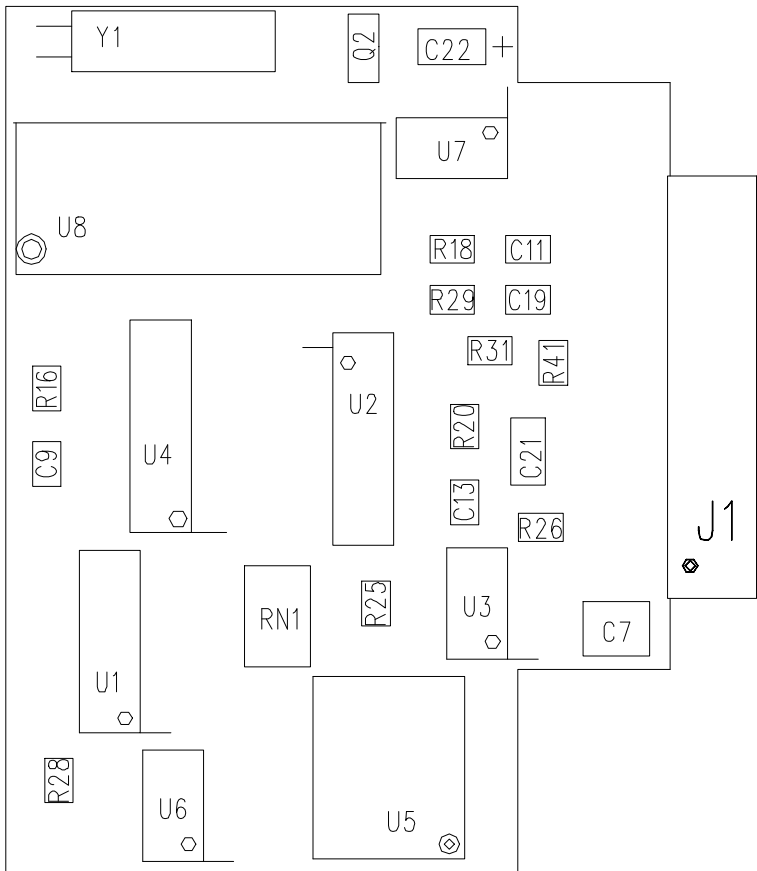
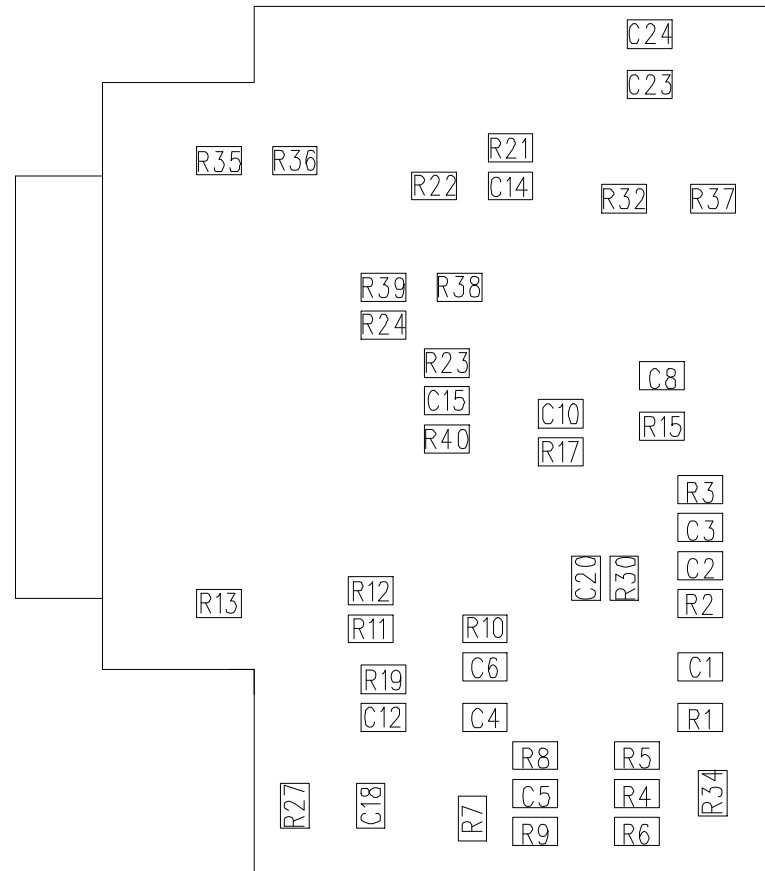

Figure 8 - ST-25AMC/AMT Schematic Diagram



TOP SIDE VIEW



BOTTOM SIDE VIEW

**Figure 9 - ST-25AMC/AMT Component Locator**